

KENWOOD

AUDIO VIDEO STEREO RECEIVER

KR-V5570

INSTRUCTION MANUAL

KENWOOD CORPORATION

For your records

Record the serial number, found on the back of the unit, in the spaces designated on the warranty card, and in the space provided below. Refer to the model and serial numbers whenever you call upon your dealer for information or service on this product.

Model _____ Serial Number _____

Unpacking

Unpack the unit carefully and make sure that all accessories are put aside so they will not be lost. Examine the unit for any possibility of shipping damage. If your unit is damaged or fails to operate, notify your dealer immediately. If your unit was shipped to you directly, notify the shipping company without delay. Only the consignee (the person or company receiving the unit) can file a claim against the carrier for shipping damage.

We recommend that you retain the original carton and packing materials for use should you transport or ship the unit in the future.

Accessories

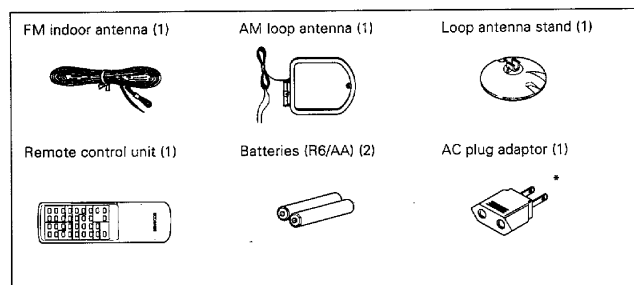

* Use to adapt the plug on the power cord to the shape of the wall outlet. (Accessory only for regions where use is necessary.)

Before applying power

Caution: Read this page carefully to ensure safe operation.

KR-V5570 (En)

Units are designed for operation as follows.

U.S.A. and Canada AC 120 V only
Australia AC 240 V only

U.K. and Europe AC 230 V only
***Other countries** AC 110-120 / 220-240 V switchable

*AC voltage selection

The AC voltage selector switch on the rear panel is set to the voltage that prevails in the area to which the unit is shipped. Before connecting the power cord to your AC outlet, make sure that the setting position of this switch matches your line voltage. If not, it must be set to your voltage in accordance with the following direction.

Note:
 Our warranty does not cover damage caused by excessive line voltage due to improper setting of the AC voltage selector switch.



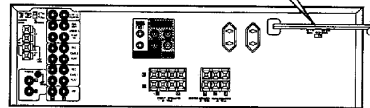
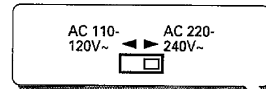

AC voltage selector switch



Move switch lever to match your line voltage with a small screwdriver or other pointed tool.

Safety precautions

WARNING : TO PREVENT FIRE OR ELECTRIC SHOCK, DO NOT EXPOSE THIS APPLIANCE TO RAIN OR MOISTURE.

 <div style="border: 1px solid black; padding: 2px; text-align: center;"> CAUTION <small>RISK OF ELECTRIC SHOCK DO NOT OPEN</small> </div> 	<p>CAUTION: TO REDUCE THE RISK OF ELECTRIC SHOCK, DO NOT REMOVE COVER (OR BACK). NO USER-SERVICEABLE PARTS INSIDE, REFER SERVICING TO QUALIFIED SERVICE PERSONNEL.</p>
	<p>THE LIGHTNING FLASH WITH ARROWHEAD SYMBOL, WITHIN AN EQUILATERAL TRIANGLE, IS INTENDED TO ALERT THE USER TO THE PRESENCE OF UNINSULATED "DANGEROUS VOLTAGE" WITHIN THE PRODUCT'S ENCLOSURE THAT MAY BE OF SUFFICIENT MAGNITUDE TO CONSTITUTE A RISK OF ELECTRIC SHOCK TO PERSONS.</p>
	<p>THE EXCLAMATION POINT WITHIN AN EQUILATERAL TRIANGLE IS INTENDED TO ALERT THE USER TO THE PRESENCE OF IMPORTANT OPERATING AND MAINTENANCE (SERVICING) INSTRUCTIONS IN THE LITERATURE ACCOMPANYING THE APPLIANCE.</p>

For the U.S.A.

FCC WARNING

This equipment may generate or use radio frequency energy. Changes or modifications to this equipment may cause harmful interference unless the modifications are expressly approved in the instruction manual. The user could lose the authority to operate this equipment if an unauthorized change or modification is made.

NOTE:

This equipment has been tested and found to comply with the limits for a Class B digital device, pursuant to Part 15 of the FCC Rules. These limits are designed to provide reasonable protection against harmful interference in a residential installation. This equipment may cause harmful interference to radio communications, if it is not installed and used in accordance with the instructions. However, there is no guarantee that interference will not occur in a particular installation. If this equipment does cause harmful interference to radio or television reception, which can be determined by turning the equipment off and on, the user is encouraged to try to correct the interference by one or more of the following measures:

- Reorient or relocate the receiving antenna.
- Increase the separation between the equipment and receiver.
- Connect the equipment into an outlet on a circuit different from that to which the receiver is connected.
- Consult the dealer or an experienced radio / TV technician for help.

For the U.S.A.

Note to CATV system installer:

This reminder is provided to call the CATV system installer's attention to Article 820-40 of the NEC that provides guidelines for proper grounding and, in particular, specifies that the cable ground shall be connected to the grounding system of the building, as close to the point of cable entry as practical.

Special features

DOLBY PRO LOGIC & DOLBY 3 STEREO

The surround system reproduces video software program carrying the **DOLBY SURROUND** mark with similar acoustic effects to movie theaters.

The **DOLBY PRO LOGIC** mode controls the audio signals of the Front Left/Right, Center and Rear surround channels using the built-in directivity enhancer circuit to reproduce the feeling of sound motions realistically.

The **DOLBY 3 STEREO** mode can reproduce the motions of sound even when only the front and center speakers are used, by providing proper acoustic position using the directivity enhancer circuit.

- 21

Station preset

This unit incorporates a function for storing received stations in preset memory with a simple operation. It is very convenient to preset the stations you like. The preset stations can be recalled also very easily.

- 18

TAPE 2(MONITOR)

The **TAPE2(MONITOR)** jacks of this unit accept the connection of a cassette deck, graphic equalizer, surround processor, etc. When a 3-head cassette deck is connected to the **TAPE2(MONITOR)** jacks, it is possible to monitor the sound which has just been recorded during recording.

- 16

Contents

Caution : Read the pages marked **▲** carefully to ensure safe operation.

Before applying power	2
▲ Before applying power	2
▲ Safety precautions	2
Special features	3
▲ IMPORTANT SAFEGUARDS	4
System connections	6
FM DE-EMPHASIS / CHANNEL SPACE switch	9
Controls and indicators	10
Operation of remote control unit	12
Playing music	13
Sound adjustment functions	14
Recording	16
Recording	16
Copying tape (Tape dubbing)	16
Broadcast reception	17
Receiving broadcast station	17
Receiving radio station by specifying its frequency	18
Storing radio stations in memory (Station preset)	19
Receiving a preset station	19
Receiving all preset stations in order	19
Operation of video components	20
Playback of videotape	20
Recording of video source	20
Presence play	21
DOLBY PRO LOGIC surround arrangement	22
DOLBY PRO LOGIC surround playback	23
DOLBY 3 STEREO adjustment and playback	24
In case of difficulty	25
▲ Specifications	26

IMPORTANT SAFEGUARDS

Caution: Read this page carefully to ensure safe operation.

KR-V5570 (En)

Please read all of the safety and operating instructions before operating this appliance. Adhere to all warnings on the appliance and in the instruction manual. Follow all the safety and operating instructions. These safety and operating instructions should be retained for future reference.

- 1. Power sources** – The appliance should be connected to a power supply only of the type described in the instruction manual or as marked on the appliance. If you are not sure of the type of power supply to your home, consult your appliance dealer or local power company. For appliances intended to operate from battery power, or other sources, refer to the instruction manual.
- 2. Power-cord protection** – Power-supply cords should be routed so that they are not likely to be walked on or pinched by items placed upon or against them, paying particular attention to cords at plugs, convenience receptacles, and the point where they exit from the appliance.

Never pull or stretch the cord.



- 3. CAUTION – Polarization** – This appliance may be equipped with a polarized alternating-current line plug (a plug having one blade wider than the other). This plug will fit into the power outlet only one way. This is a safety feature. If you are unable to insert the plug fully into the outlet, try reversing the plug. If the plug should still fail to fit, contact your electrician to replace your obsolete outlet. Do not defeat the safety purpose of the polarized plug.
- 4. Ventilation** – Slots and openings in the cabinet are provided for ventilation and to ensure reliable operation of the appliance and to protect it from overheating, and these openings must not be blocked or covered. The appliance should be situated so that its location or position does not interfere with its proper ventilation.
To maintain good ventilation, do not put records or a table-cloth on the appliance. Place the appliance at least 10 cm away from the walls.
Do not use the appliance on a bed, sofa, rug or similar surface that may block the ventilation openings. This appliance should not be placed in a built-in installation such as a bookcase or rack unless proper ventilation is provided or the manufacturer's instructions have been adhered to.

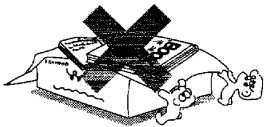

- 5. Water and moisture** – The appliance should not be used near water - for example, near a bathtub, washbowl, kitchen sink, laundry tub, in a wet basement, or near a swimming pool, etc.

- 6. Temperature** – The appliance may not function properly if used at extremely low, or freezing temperatures. The ideal ambient temperature is above +5°C (41°F).
- 7. Heat** – The appliance should be situated away from heat sources such as radiators, heat registers, stoves, or other appliances (including amplifiers) that produce heat.
- 8. Electric shock** – Care should be taken so that objects do not fall and liquid is not spilled into the enclosure through openings. If a metal object, such as a hair pin or a needle, comes into contact with the inside of this appliance, a dangerous electric shock may result. For families with children, never permit children to put anything, especially metal, inside this appliance.



- 9. Enclosure removal** – Never remove the enclosure. If the internal parts are touched accidentally, a serious electric shock might occur.

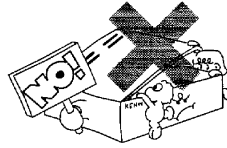

- 10. Magnetic fields** – Keep the appliance away from sources of magnetic fields such as TV sets, speaker systems, radios, motorized toys or magnetized objects.
- 11. Cleaning** – Unplug this appliance from the wall outlet before cleaning. Do not use volatile solvents such as alcohol, paint thinner, gasoline, or benzene, etc. to clean the cabinet. Use a clean dry cloth.
- 12. Accessories** – Do not place this appliance on an unstable cart, stand, tripod, bracket, or table. The appliance may fall, causing serious injury to a child or adult, and serious damage to the appliance. Use only with a cart, stand, tripod, bracket, or table recommended by the manufacturer, or sold with the appliance. Any mounting of the appliance should follow the manufacturer's instructions, and should use a mounting accessory recommended by the manufacturer. An appliance and cart combination should be moved with care. Quick stops, excessive force, and uneven surfaces may cause the appliance and cart combination to overturn.



Caution: Read this page carefully to ensure safe operation.

KR-V5570 (E)

13. Lightning – For added protection for this appliance during a lightning storm, or when it is left unattended and unused for long periods of time, unplug it from the wall outlet and disconnect the antenna or cable system. This will prevent damage to the appliance due to lightning and power-line surges.

14. Abnormal smell – If an abnormal smell or smoke is detected, immediately turn the power OFF and unplug the appliance from the wall outlet. Contact your dealer or nearest service center.

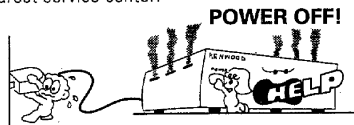

15. Damage requiring service – The appliance should be serviced by qualified service personnel when:

- A. The power-supply cord or the plug has been damaged.
- B. Objects have fallen, or liquid has been spilled into the appliance.
- C. The appliance has been exposed to rain or water.
- D. The appliance does not appear to operate normally by following the instruction manual. Adjust only those controls that are covered by the instruction manual as an improper adjustment of other controls may result in damage and will often require extensive work by a qualified technician to restore the appliance to its normal operation.
- E. The appliance has been dropped, or the enclosure damaged.
- F. The appliance exhibits a marked change in performance.

16. Servicing – The user should not attempt to service the appliance beyond that described in the instruction manual. All other servicing should be referred to qualified service personnel.

17. Outdoor antenna grounding – If an outside antenna is connected to the appliance, be sure the antenna system is grounded so as to provide some protection against voltage surges and built up static charges. Article 810 of the National Electrical Code ANSI/NFPA 70, provides information with respect to proper grounding of the mast and supporting structure, grounding of the lead-in wire to an antenna discharge unit, size of grounding conductors, location of antenna discharge unit, connection to grounding electrodes, and requirements for the grounding electrode. See Figure.

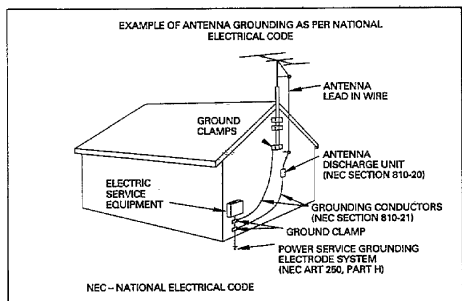

18. Power lines – An outside antenna system should not be located in the vicinity of overhead power lines or other electric light or power circuits, or where it can fall into such power lines or circuits. When installing an outside antenna system, extreme care should be taken to keep from touching such power lines or circuits as contact with them might be fatal.

19. AC outlets – Do not connect other audio equipment with a power consumption larger than that specified to the AC outlet on the rear panel. Never connect other electrical appliances, such as an iron or toaster, to it to prevent fire or electric shock.

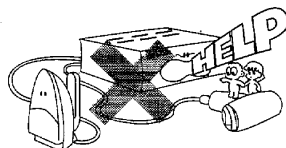

20. Overloading – Do not overload wall outlets, extension cords, or integral convenience receptacles as this can result in a risk of fire or electric shock.

21. Attachment – Do not use attachments not recommended by the appliance manufacturer as they may cause hazards.

22. Replacement parts – When replacement parts are required, be sure the service technician has used replacement parts specified by the manufacturer or have the same characteristics as the original parts. Unauthorized substitutions may result in fire, electric shock, or other hazards.

23. Safety check – Upon completion of any service or repairs to this appliance, ask the service technician to perform safety checks to determine that the appliance is in proper operating condition.

Notes:

- 1. Item 3 is not required except for grounded or polarized equipment.
- 2. Item 17 and 18 are not required except for units provided with antenna terminals.
- 3. Item 17 complies with UL in the U.S.A.

System connections

KR-V570 (En)

Make connection as shown below. When connecting the related system components, refer also to the instruction manuals of the related components.
Do not plug in the power lead until all connections are completed.

Malfunction of microcomputer
If operation is not possible or erroneous display appears even though all connections have been made properly, reset the microcomputer referring to "In case of difficulty".

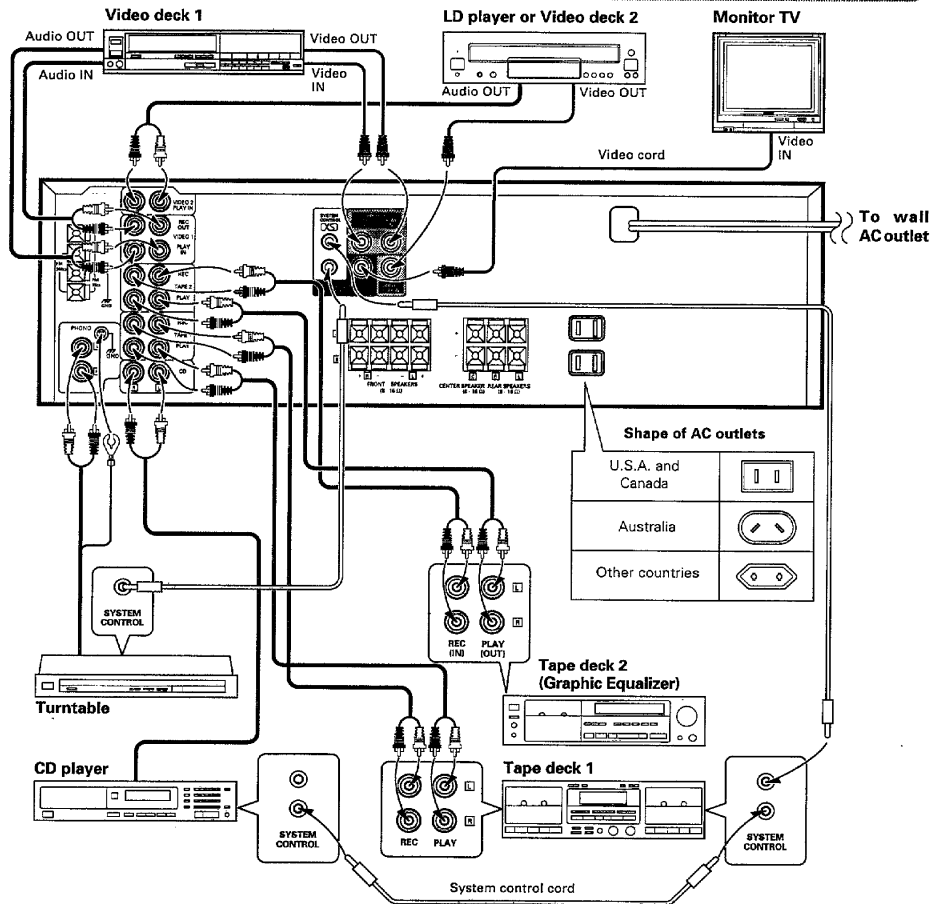

Automatic operation

When this unit is connected to KENWOOD system components such as a cassette deck and CD player through system control cords and the input source is selected with the INPUT SELECTOR, the selected component starts to play automatically. Inversely, playing a component automatically selects that source as the input to this unit. The automatic operation also occurs when the provided remote control is used.
(Automatic operation is not possible with **Tape deck 2** or **Video** machines.)

Notes

1. Connect all cords firmly. If connections are loose, there could be loss of sound or noise produced.
2. When plugging and unplugging connection cords, be sure to first remove the power cord from the AC outlet. Plugging / unplugging connection cords without removal of the power cord can cause malfunctions or damage to the unit.
3. Do not connect up a power source which is larger than that indicated on the socket at the rear of the unit.
4. Insert the system control plugs completely into the jacks.
5. If the system control cords or audio cords are not connected properly, the remote control or automatic operation between system components will not work properly.

Connection of speakers

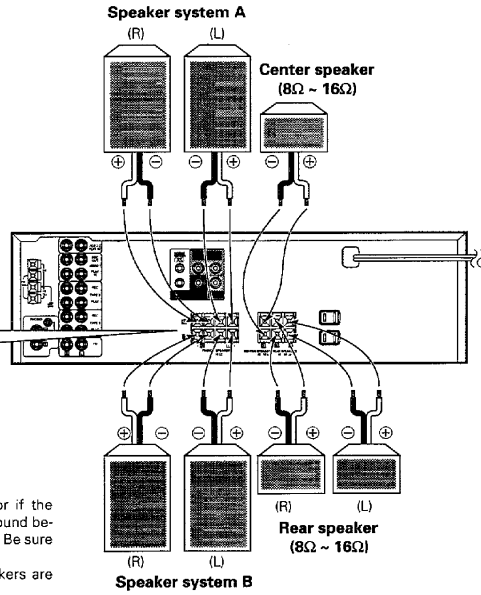
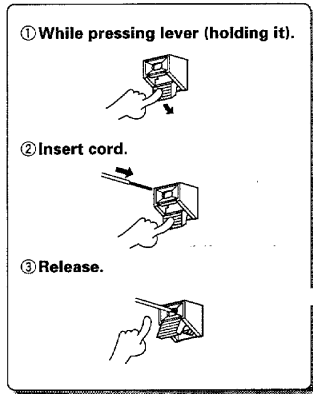

- Never short-circuit the + and - speaker cords.
- If the left and right speakers are connected inversely or if the speaker cords are connected with reversed polarity, the sound becomes unnatural with ambiguous acoustic image positioning. Be sure to connect the speakers and speaker cords correctly.
- Proper sound will not be produced unless two rear speakers are connected.

Connection method to each antenna terminal

- ① While pressing lever (holding it).
- ② Insert cord.
- ③ Release.

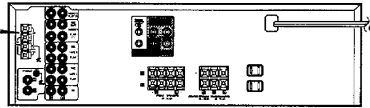
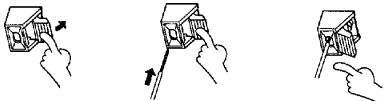

Connection of AM antenna

AM loop antenna connection

The supplied antenna is for indoor use. Place it as far as possible from the main system, TV set, speaker cords and power cord, and set it to a direction which provides the best reception.

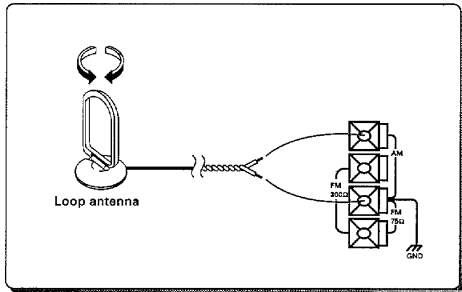

AM outdoor antenna connection

If the reception is poor when the AM loop antenna is used, distribute a vinyl-coated wire of more than 6 meters outdoors, without disconnecting the loop antenna.

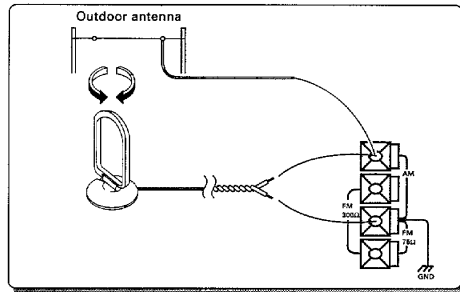

Connection of FM antenna

FM indoor antenna connection

The accessory antenna is for temporary indoor use only. For stable signal reception we recommend using an outdoor antenna. Remove the indoor antenna if you connect one outdoors.

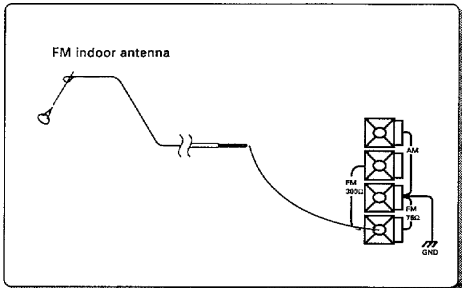

Connection of FM outdoor antenna

Lead the 75Ω coaxial cable connected to the FM outdoor antenna into the room and connect it to the FM 75Ω terminal.

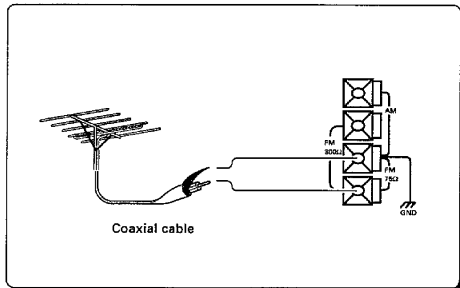



FM DE-EMPHASIS / CHANNEL SPACE switch (Except for U.S.A., Canada and Australia)

The FM DE-EMPHASIS / CHANNEL SPACE switch on the rear panel is set to the correct setting that prevails in the area to which the unit is shipped. However, if the FM DE-EMPHASIS / CHANNEL SPACE setting is not matched to the area where the unit is to be used; for instance, when you moved from area 1 to area 2 or vice versa, desired reception of AM / FM broadcasts is not expected. In this case, change the FM DE-EMPHASIS / CHANNEL SPACE setting in accordance with the area corresponding to the table. The FM DE-EMPHASIS is switched over at the same time.

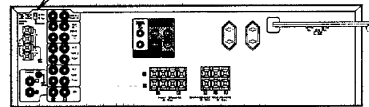
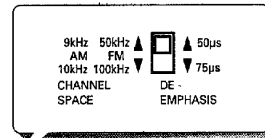

- When changing the setting of the FM DE-EMPHASIS / CHANNEL SPACE switch, first disconnect the power cord of the amplifier, then reset the channel space switch, connect the power cord again, and turn the power on.

Area	CHANNEL SPACE freq.	FM DE-EMPHASIS
1. U.S.A., Canada and South American countries	FM: 100kHz AM: 10kHz	75 μ s
2. Other countries	FM: 50kHz AM: 9kHz	50 μ s

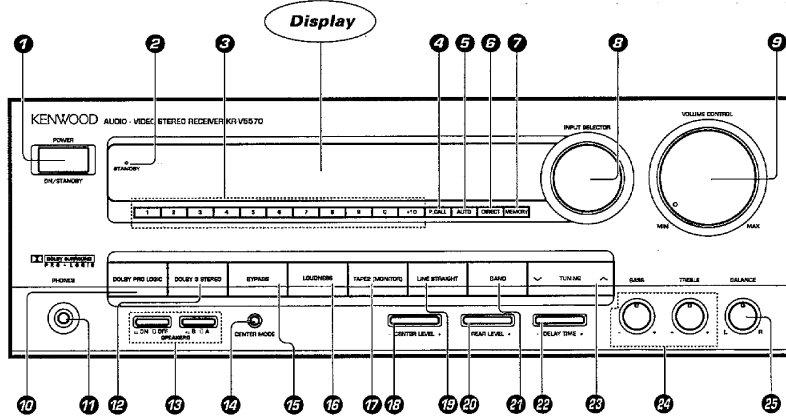
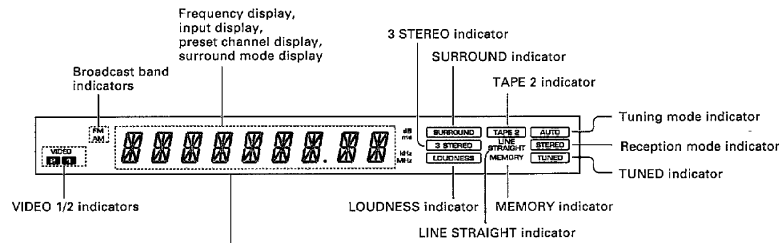

- ① **POWER key**
- ② **STANDBY indicator**
- ③ **Numeric keys**
- ④ **P.CALL key**
Press to recall a preset station.
- ⑤ **AUTO key**
Press to select the auto tuning mode.
- ⑥ **DIRECT key**
Press for direct station tuning based on numerical input.
- ⑦ **MEMORY key**
Press to preset a station in memory.
- ⑧ **INPUT SELECTOR knob**
Turn to select the input sources.
- ⑨ **VOLUME CONTROL knob**
- ⑩ **DOLBY PRO LOGIC key**
- ⑪ **PHONES jack**
Used for headphone listening.
- ⑫ **DOLBY 3 STEREO key**
- ⑬ **SPEAKERS keys**
Press to select the A or B speaker systems.
- ⑭ **CENTER MODE key**
Press to select the center mode of the DOLBY PRO LOGIC and DOLBY 3 STEREO surround play.
- ⑮ **BYPASS key**
Press to cancel the surround modes.
- ⑯ **LOUDNESS key**
Press to enhance low frequencies.
- ⑰ **TAPE2 (MONITOR) key**
- ⑱ **CENTER LEVEL key**
- ⑲ **LINE STRAIGHT key**
Press to reproduce the source with a higher sound quality.
- ⑳ **REAR LEVEL key**
- ㉑ **BAND key**
Press to switch the broadcast band.
- ㉒ **DELAY TIME key**
Press to adjust delay time.
- ㉓ **TUNING key**
Press to tune broadcast stations.
- ㉔ **TONE control knobs**
- ㉕ **BALANCE control knob**
Turn to adjust the volume balance between left and right.

STANDBY mode of POWER switch

When the power cord of this system is plugged into an AC outlet, the STANDBY indicator lights up regardless of the ON/OFF setting of the POWER switch. This indicates that a small amount of current is being supplied to the unit to back up the memory contents. This mode is referred to as the Standby mode. While the STANDBY indicator is lit, the power of the system can be switched ON/OFF from the remote control unit.

Remote control unit

The remote control unit provided with the receiver can also control KENWOOD cassette decks, and CD player connected to the receiver through system control cords. For details of the controllable functions, refer to the instruction manuals of these components.

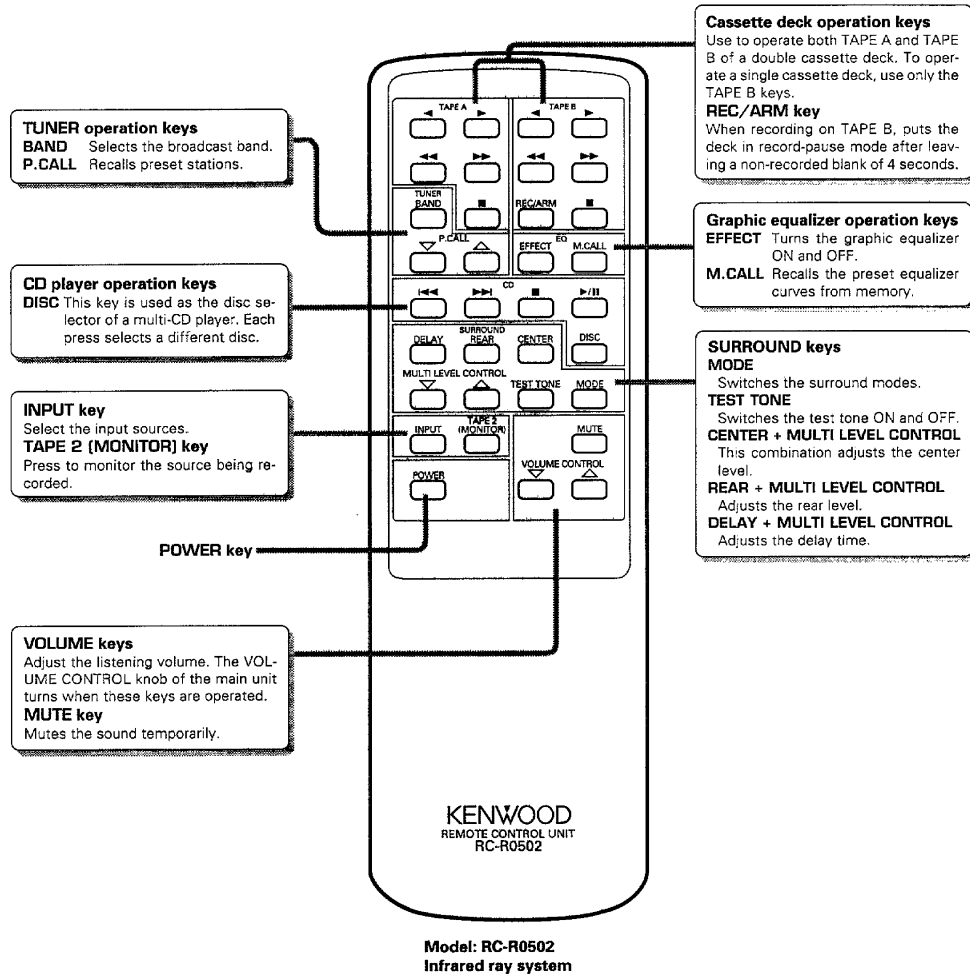

Operation of remote control unit

KR-V5670 [En]

12 Loading batteries

1 Remove the cover.

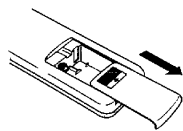

2 Insert batteries.

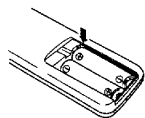

3 Close the cover.

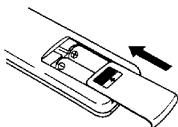

- Insert two AA-size (R6 / SUM-3) batteries as indicated by the polarity marking.

Operation procedure

Plug the power cord of the system into an AC wall outlet, and press the **POWER** key on the remote control unit to turn the power on. When the power is turned on, press the key of the source component to be operated.

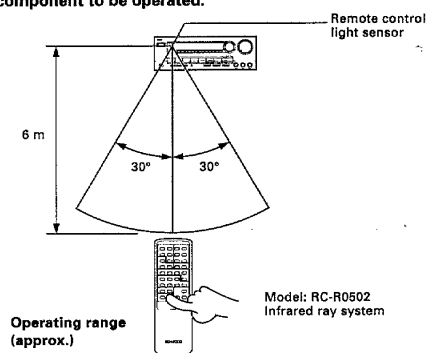

- Components connected via the system control cords, such as the CD player, can also be remote-controlled. In this case, please read the instruction manual supplied with your components.
- When two operation keys on the remote control unit are pressed successively, press each key securely reserving an interval of more than 1 second for each press.

Notes

1. The supplied batteries are intended for use in operation checks. Therefore, their lives may be shorter than ordinary batteries.
2. When the remote-controllable distance gets shorter than before, replace both batteries with new ones.
3. Malfunction may occur if direct sunlight or the light of a high-frequency lighting fluorescent lamp enters the remote control light sensor. In such a case, change the system installation position to prevent the malfunction.

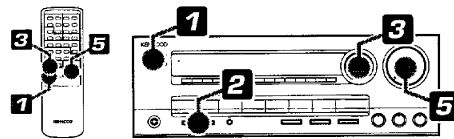

1 Turn the power ON.

POWER
ON/STANDBY

2 Select the SPEAKERS switch setting.

SPEAKERS
ON OFF B A

3 Select the input source.

INPUT SELECTOR

4 Play the selected source.

5 Adjust the volume.

VOLUME CONTROL
MIN MAX

To decrease volume
To increase volume

- OFF
Sound is not output from the speakers. Use this setting for listening through headphones, etc.
- ▣ ON, □ A
Sound is output from the speakers connected to the SPEAKERS A terminals on the rear panel.
- ▣ ON, ▣ B
Sound is output from the speakers connected to the SPEAKERS B terminals on the rear panel.

- If the cassette deck(s), CD player and/or turntable is connected through system control cords, the component of the selected input source starts to play automatically.
- The input sources are switched in the following order.
- | | |
|-----------------------------|-----------------------------------|
| ① TUNER (frequency display) | The selected source is displayed. |
| ② TAPE 1 | |
| ③ TAPE 2 | |
| ④ CD | |
| ⑤ PHONO | |
| ⑥ PHONO | |
- The selected input source is held in memory for about 3 days even after the power cord is unplugged from the mains outlet.

- The sound of input source cannot be listened to while TAPE 2 is ON. (Except when the graphic equalizer is connected - (16))
- When the volume is adjusted from the remote control unit, the VOLUME CONTROL knob rotates.

Sound adjustment functions

KR-V5570 (En)

14

Adjusting the tone

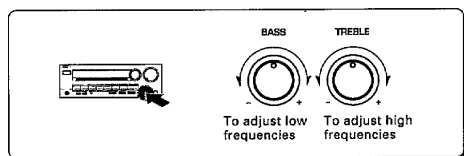

Adjusting the left/right sound balance

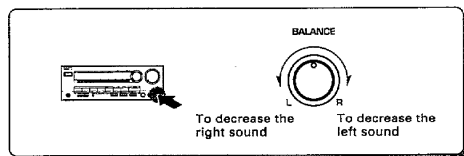

Using the LOUDNESS key

When listening at a low volume, the loudness function allows to compensate the low frequencies which human ears have difficulty in hearing at a low volume.

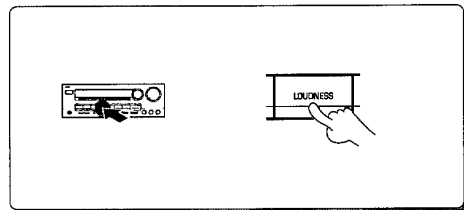

To cancel the loudness function
Press the key again.

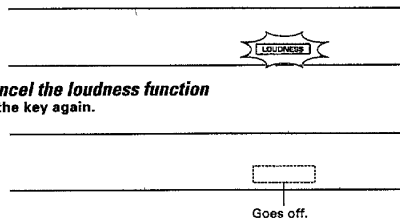

To mute sound temporarily

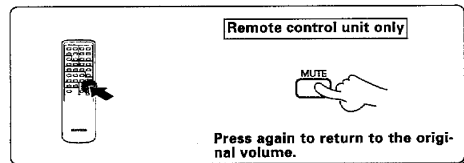

• The VOLUME CONTROL indicator of the receiver unit blinks.

To listen through headphones

① Set the SPEAKERS switches to OFF.



ON OFF A B A

SPEAKERS

② Plug headphones.

PHONES



③ Adjust the volume.

VOLUME CONTROL

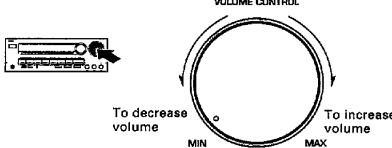

To decrease volume MIN MAX To increase volume

Line-straight playback

This feature allows to enjoy music sources such as CD with an even higher sound quality.

① Select the source to be played.

INPUT SELECTOR



② Press the LINE STRAIGHT key.

LINE STRAIGHT



③ Play the source.



- The tone control functions are defeated during line-straight play.
- The line-straight play is cancelled when a key associated with surround play is pressed.

To cancel
Press the key again.

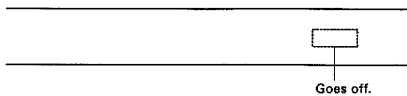

To record a music source

① Select the source to be recorded.

INPUT SELECTOR



Select an input source other than TAPE 1.

② Put the cassette deck in record-pause mode.

③ Play the source and start recording.

- When recording is made on a KENWOOD cassette deck which is connected through system control cords, the input selector setting is fixed to protect the recording status. In this case, if you want to change the recorded source, first stop recording.

Copying tape (Tape dubbing TAPE 1 → TAPE 2)

Play the cassette deck connected to the TAPE 1 jacks and start recording of the cassette deck connected to the TAPE 2 jacks.

Copying tape (Tape dubbing TAPE 2 → TAPE 1)

① Press the TAPE 2 key.



② Select a source other than TAPE 1.

INPUT SELECTOR



③ Play cassette deck 2 and start recording on cassette deck 1.

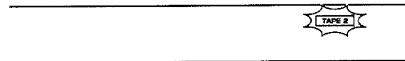

- For copying a tape using a double cassette deck, read the instruction manual of the double cassette deck.

Regarding TAPE 2 (MONITOR)

A cassette deck or graphic equalizer can be connected to this unit's TAPE 2 (MONITOR) terminals. If you connect a graphic equalizer, turn the TAPE 2 (MONITOR) key ON. If you connect a 3-head cassette deck, you can monitor the source sound, or the sound being recorded, while recording. Pressing the TAPE 2 (MONITOR) key lets you compare the recorded sound and the source sound. Refer to the operating manual for the component you connected for further details.

Broadcast reception

KR-V5570 (En)

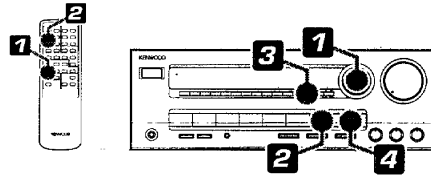

Receiving broadcast station

1 Select the TUNER input.

INPUT SELECTOR

2 Select the broadcast band.

BAND

3 Select the tuning method.

P.CALL AUTO DIRECT MEMORY

4 Select a station.

To increase frequency

To decrease frequency

TUNING

The input sources are switched in the following order.

① TUNER (frequency display) Frequency display

② TAPE 1

③ VIDEO 1

④ VIDEO 2

⑤ []

⑥ PHONO

- The last frequency tuned before is displayed.

Each press switches the band as follows:

① FM

② AM

Each press switches the tuning method as follows:

① AUTO lit (auto tuning)

② AUTO not lit (manual tuning)

- Usually, set the switch to **AUTO** (auto tuning).

Select manual tuning when noise interferes due to weak radio wave. (The stereo broadcasting is received in monaural during manual tuning.)

Frequency display "TUNED" lights up when a station is tuned.

For Auto Tuning: Press \vee or \wedge once and the tuner automatically tunes to a receivable station.

For Manual Tuning: Press repeatedly until the frequency you desire is tuned. You can also tune by holding the button down.

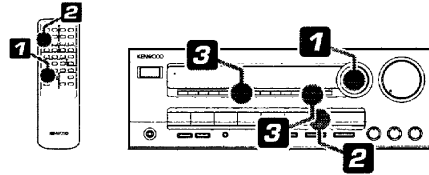

Receiving radio station by specifying its frequency

1 Select the TUNER input.

2 Select the broadcast band.

3 Specify the frequency.

① Press the DIRECT key.

② Enter the frequency of the desired station.

The input sources are switched in the following order.

- ① TUNER (frequency display)
- ② TAPE 1
- ③ VIDEO 1
- ④ VIDEO 2
- ⑤ CD
- ⑥ PHONO

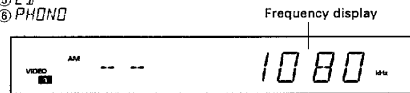

Each press switches the band as follows:

- ① FM
- ② AM

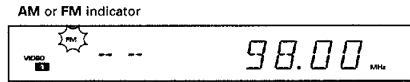

Press the numeric keys according to the frequency to be tuned as shown below.

Desired station	Order of pressing numeric keys	
FM 90 MHz	[9], [0], [0] [9], [0], [0], [0]	* (100 kHz space) (50 kHz space)
FM 102.5 MHz	[1], [0], [2], [5] [1], [0], [2], [5], [0]	(100 kHz space) (50 kHz space)
AM (MW) 810 kHz	[8], [1] [8], [1], [0]	(10 kHz space) (9 kHz space)
AM (MW) 1260 kHz	[1], [2], [6] [1], [2], [6], [0]	(10 kHz space) (9 kHz space)

*FM DE-EMPHASIS/CHANNEL SPACE switch → [3]

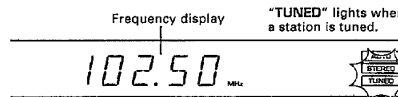

● If you commit a mistake, repeat step 3 again.

Preparation

- Tune the station to be stored in memory.

19

Storing radio stations in memory (Station preset)**1 Press the MEMORY key during receiving a station.**

P.CALL AUTO DIRECT MEMORY



Lights up (for 5 sec.)

102.50 MHz

**Proceed to step 2 within 5 sec.**

(If more than 5 sec. have elapsed, press the MEMORY key again.)

2 Select one of the preset numbers from 1 to 20.

1 2 3 4 5 6 7 8 9



Press the numeric keys in the following order.

To store in "15" [+10], [5]

To store in "20" [+10], [+10], [0]

- Repeat steps 1 and 2 for each of the stations to be stored in memory.
- You can store a combined total up to 20 FM and AM stations.
- If a station is stored in a preset number which already stores a station memory under it, the previous memory is replaced by the new memory content.
- Once the memory content has been preset, it is held for about 3 days even after the power cord is unplugged from the mains outlet.

Receiving a preset station**Press the preset number of the desired station.**

- Select the TUNER input with the INPUT SELECTOR.



INPUT SELECTOR



②

1 2 3 4 5 6 7 8 9



FM 15 102.50 MHz

Press the numeric keys in the following order.

To recall "15" [+10], [5]

To recall "20" [+10], [+10], [0]

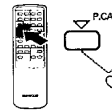
Receiving all preset stations in order**Press the P.CALL key.**

(Remote control unit)

P.CALL AUTO



(Main-unit)

- Every time the key is pressed, the next station in the order of the preset number is received.

If the key is held pressed, ...Preset stations will be received successively for about half a second each.

Operation of video components

KR-V5570 (En)

For the connections and operations, also read carefully the instruction manuals of the video components.

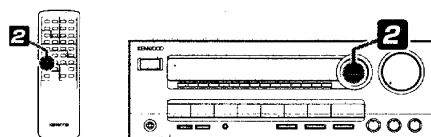

Playback of videotape

1 Turn the power of the monitor TV ON.

2 Select the VIDEO 1 input.



The input sources are switched in the following order:

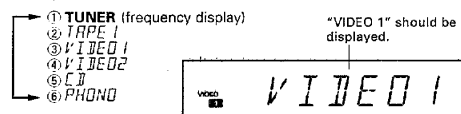

- Select the input to which a video deck is connected.

3 Play the video deck.

Recording of video source

1 Connect the video source component to be played.

2 Select the VIDEO 2 input.



- Connect the component to be played to the VIDEO 2 jacks.
- The connectable components include a video deck (playback only), video camera (playback only), LD player or DBS tuner.

The input sources are switched in the following order:

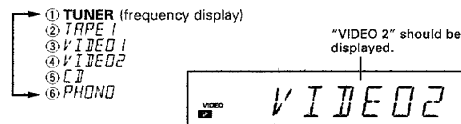

3 Play the source component.

4 Start recording on the recording video deck.

- Start recording with the video deck which is connected to the VIDEO 1 jacks.

KR-V5570 (En)

Presence play

KR-V5570 (En)

The surround modes allow to enjoy the feeling of presence in music. Select the mode according to the source or components played. For the connections of the rear and/or center speakers, refer to "Connection of speakers".

DOLBY PRO LOGIC surround mode

-[22]

Video and LD software programmes carrying the  mark contain recording of the same Dolby Surround data as those used in movie theatres. The DOLBY PRO LOGIC surround mode uses the Dolby Surround data and brings into home a similar sound field with full of presence to movie theatres.

To use this mode, connect the rear (and center) speakers.

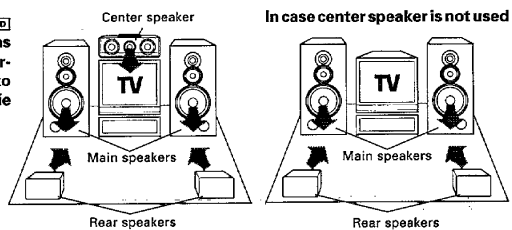

DOLBY 3 STEREO mode

-[24]

If the left and right speakers are installed apart from each other, the center acoustic image (words, etc.) may vary depending on the listener's position. The DOLBY 3 STEREO mode provides an improved positioning of the center acoustic image regardless of the listening position.

To use this mode, connect the center speaker.

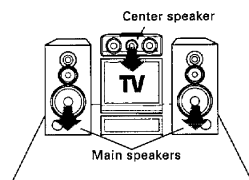

This mode provides a similar Dolby Surround effect used in movie theaters when a video (or LD) software program carrying the **DOLBY SURROUND** mark is played.

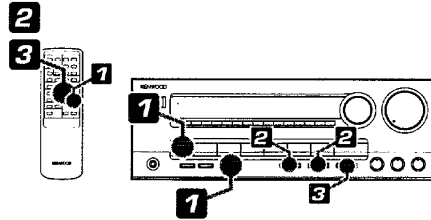

DOLBY PRO LOGIC surround arrangement

1 Activate the DOLBY PRO LOGIC mode.

①

② **Select the center mode.**

CENTER MODE

2 Adjust the volume balance.

① **Generate the test tone.**

TEST TONE

② **Align the speaker volumes with the main speaker volume.**

(1) REAR CENTER Center speaker
Rear speakers

(2) MULTI LEVEL CONTROL
To increase

To decrease

③ **Stop the test tone.**

TEST TONE

3 Adjust the delay time.

① **DELAY**

② MULTI LEVEL CONTROL
To increase

To decrease

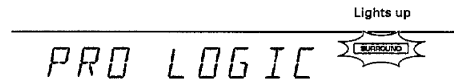

Each press of the **CENTER MODE** key switches the center modes as follows:

- ① **NORMAL** : When the center speaker is a compact-sized speaker.
- ② **WIDE BAND** : When the center speaker is a medium- or large-sized speaker.
- ③ **PHANTOM** : When the center speaker is not used.

- If you cannot tell whether your center speaker is compact or medium-sized, try two modes and select according to your liking.
- The selected center mode is automatically stored in memory and held unless it is changed later.

- The test tone which is heard like noise moves between speakers at an interval of 1.5 sec.

In NORMAL and WIDE BAND modes:

- Left (L)
- Center (C)
- Right (R)
- Surround (Rear) (S)

In PHANTOM mode:

- Left (L)
- Right (R)
- Surround (Rear) (S)

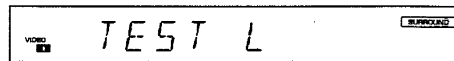

- Be sure to adjust from your listening position.
- When a key is pressed, the corresponding volume level to the key is displayed on the display. While the level is displayed, it can be adjusted by 1 dB per press of the key.
- The volume levels can be adjusted in the range from -10 dB to +10 dB.
- The center and rear levels are stored in memory as the common settings with the DOLBY 3 STEREO mode.

Each press switches the band as follows:

- ① **DELAY** (DELAY TIME)
- ② **CENTER** (CENTER LEVEL)
- ③ **REAR** (REAR LEVEL)

- The delay time can be adjusted in the range from 15 ms to 30 ms, in 5 ms steps.
- Once the delay time has been preset, it is held until it is re-set later.



How to calculate the DELAY TIME (23)

Before playing a video (or LD) software program carrying the  mark, be sure to complete the "DOLBY PRO LOGIC surround arrangement".

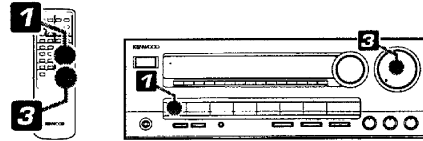

DOLBY PRO LOGIC surround playback

1 Activate the DOLBY PRO LOGIC mode.

Each press of the key switches the modes as follows:

- ① PRO LOGIC
- ② 3 STEREO
- ③ OFF (BYPASS)

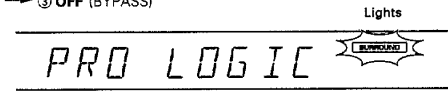

2 Play a video software program.

3 Adjust the volume.

To cancel DOLBY PRO LOGIC SURROUND play

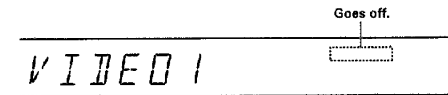

How to calculate the proper delay time

Assuming that the distance from the front speaker is A meters and the distance from the rear speakers is B meters.

- ① Use the delay time calculation chart on the right.

Example:
When A = 3 m,
B = 3 m,
the delay time is
20 ms.

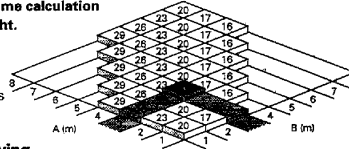

- ② Use the following formula for calculation.

$$\text{Delay time} = 20 + 3 \times (A - B) \text{ (Unit: ms)}$$

Set the delay time to the number closest to the one you found using either method one or two.

This mode improves the positioning of the acoustic image of words, etc., by applying directivity enhancer processing and using an additional center speaker when a video software program recorded with ordinary 2-channel stereo is played.

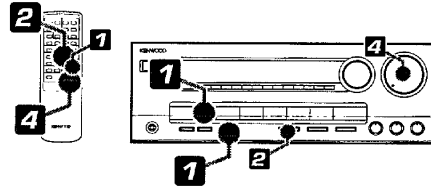

DOLBY 3 STEREO adjustment and playback

1 Activate the DOLBY 3 STEREO mode.

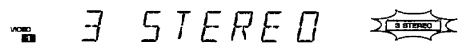
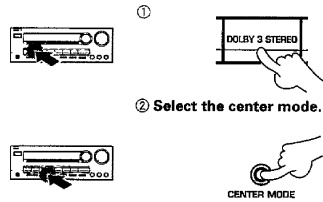

Each press of the **CENTER MODE** key switches the center modes as follows.

- ① **NORMAL** : When the center speaker is a compact-sized speaker.
- ② **WIDE BASS** : When the center speaker is a medium- or large-sized speaker.

- If you cannot tell whether your center speaker is compact or medium-sized, try two modes and select according to your liking.
- The selected center mode is automatically stored in memory and held unless it is changed later.

2 Adjust the volume balance.

① Generate the test tone.

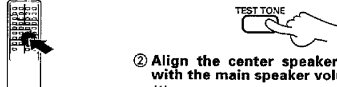

② Align the center speaker volume with the main speaker volume.

(1)



(2)

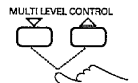

③ Stop the test tone.



- The test tone which is heard like noise moves between speakers at an interval of 1.5 sec.

- Left (L)
- Center (C)
- Right (R)

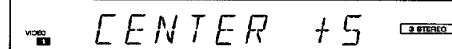
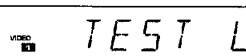

- Be sure to adjust from your listening position.
- When a key is pressed, the volume level is displayed on the display. While the level is displayed, it can be adjusted by 1 dB per press of the key.
- The center level can be adjusted in the range from -10 dB to +10 dB.
- The center level is stored in memory as the common settings with the DOLBY PRO LOGIC surround mode.

3 Play a video software program.

4 Adjust the volume.

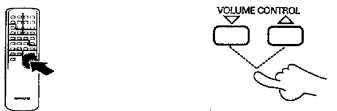

To cancel DOLBY 3 STEREO play:

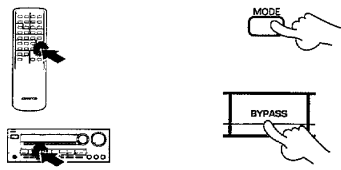

In case of difficulty

KR-V5570 (En)

Operation to reset

The microcomputer may fall into malfunction (impossibility to operate, erroneous display, etc.) when the power cord is unplugged while power is ON or due to an external factor. In this case, execute the following procedure to reset the microcomputer and return it to normal condition.

Unplug the power cord from the power socket and, while holding the POWER key depressed, plug the power cord into the socket again.

- Please note that resetting the microcomputer clears the contents stored in it returns it to the condition when it left the factory.

Remote control unit

Symptom	Cause	Remedy
Remote control operation is not possible.	<ul style="list-style-type: none"> ● Batteries are exhausted. ● The audio cords and system control cords are not connected properly. ● The remote control unit is too far away from the main system, controlling angle is too large, or there is an obstacle in between. ● The source component to be operated does not contain the tape(s) or CD. ● An attempt is made to play a tape which is being recorded in the cassette deck. 	<ul style="list-style-type: none"> ● Replace with new batteries. ● Connect properly referring to "System connection". - [3] ● Operate the remote control unit within the controllable range. - [2] ● Place the tape(s) or CD in the source component to be played. ● Wait until the recording is completed.

Amplifier

Symptom	Cause	Remedy
Sound is not output.	<ul style="list-style-type: none"> ● The speaker cords are disconnected. ● The VOLUME is set to the minimum position. ● MUTE is ON. (The MUTING indicator is blinking.) ● The SPEAKERS switches are set to OFF. ● The TAPE 2 key is set to ON. 	<ul style="list-style-type: none"> ● Connect them properly referring to "System connection". - [3] ● Adjust the volume to a proper level. ● Press the MUTING key to OFF. - [4] ● (Remote control unit.) ● Set the SPEAKERS switch(es) to ON. ● Set the TAPE 2 key to OFF.
The STANDBY indicator blinks and sound is not output.	<ul style="list-style-type: none"> ● Speaker cords are short-circuited. 	<ul style="list-style-type: none"> ● Turn the power off, eliminate the short-circuiting, then turn on the power again. - [2]
Sound is not output from one of the speakers.	<ul style="list-style-type: none"> ● The speaker cord is disconnected. ● The BALANCE control is set to an extreme position. 	<ul style="list-style-type: none"> ● Connect it properly referring "System connection". - [3] ● Adjust the Left/Right balance. - [3]
Sound is not output from the Surround rear speaker and/or center speaker, or their sound is very small.	<ul style="list-style-type: none"> ● The rear-speaker cords and/or center speaker cord are disconnected. ● A surround mode is not selected. ● The REAR VOL. and/or CENTER VOL. controls are set to the minimum level. 	<ul style="list-style-type: none"> ● Connect them properly referring to "System connection". - [3] ● Select a surround mode. - [2] ● Adjust the REAR VOL. and CENTER VOL. controls.
A hum noise is generated when PHONO input selector key is pressed.	<ul style="list-style-type: none"> ● The audio cord from the turntable is not inserted securely into the PHONO jacks. ● The turntable is not grounded. 	<ul style="list-style-type: none"> ● Insert the audio cord plugs securely into the PHONO jacks. - [3] ● Connect the grounding wire to the GND terminal on the rear panel.

Tuner

Symptom	Cause	Remedy
Radio stations cannot be received.	<ul style="list-style-type: none"> ● No antenna is connected. ● The broadcast band is not set properly. ● The frequency of the desired station is not tuned 	<ul style="list-style-type: none"> ● Connect an antenna. - [3] ● Set the broadcast band properly. ● Tune the frequency of the desired station. - [1]
Interference.	<ul style="list-style-type: none"> ● Noise due to ignition noise of an automobile. ● Noise due to an influence from an electric appliance. ● Noise due to a nearby TV set. 	<ul style="list-style-type: none"> ● Install the outdoor antenna apart from the road. ● Turn off the power of the appliance. ● Install the system more apart from the TV set.
A station which was preset cannot be received by pressing the corresponding numeric key.	<ul style="list-style-type: none"> ● The preset station belongs to a frequency that cannot be received. ● The preset memory was cleared because the power cord had been unplugged for a long period of time. 	<ul style="list-style-type: none"> ● Preset a station with a receivable frequency. ● Preset the station again. - [9]

Note



Do not use contact cleaners because it could cause a malfunction. Be specially careful against contact cleaners containing oil, for they may deform the plastic components.

Specifications

⚠ Caution : Read this page carefully to ensure safe operation.

KR-V5570 (En)

(For U.S.A. and Canada)

Audio section

Rated power output at the STEREO operation

60 watts per channel minimum RMS, both channels driven at 8 Ω, from 40 Hz to 20,000 Hz with no more than 0.06 % total harmonic distortions. (FTC)

Power output at the Surround operation

Front (1 kHz, 0.9 % T.H.D. at 8 Ω) 50 W + 50 W
Center (1 kHz, 0.9 % T.H.D. at 8 Ω) 50 W
Rear (1 kHz, 0.9 % T.H.D. at 8 Ω) 20 W + 20 W

Total harmonic distortion (1 kHz, 8 Ω) 0.03 % at 30 W
Signal to noise ratio (IHF A)

PHONO (MM) 74 dB
CD, TAPE, VIDEO 100 dB

Input sensitivity / impedance

PHONO (MM) 2.5 mV / 47 kΩ
CD, TAPE, VIDEO 200 mV / 47 kΩ

Tone controls

BASS ± 10 dB (at 100 Hz)
TREBLE ± 10 dB (at 10 kHz)
Loudness control at -30 dB level + 6 dB (100 Hz)

Video section

VIDEO inputs / outputs (Composite) 1 Vp - p / 75 Ω

FM Tuner section

Tuning frequency range 87.5 MHz ~ 108 MHz

Usable sensitivity (IHF) 13.2 dBf (1.2 μV at 75 Ω)

50 dB quieting sensitivity

STEREO 41.2 dBf (32 μV at 75 Ω)

Total harmonic distortion at 1 kHz

MONO 0.6 %

STEREO 0.7 %

Signal to noise ratio at 65 dBf (IHF)

MONO 75 dB

STEREO 68 dB

Selectivity (IHF ± 400 kHz) 50 dB

Stereo separation (IHF at 1 kHz) 40 dB

AM Tuner section

Tuning frequency range 530 kHz ~ 1,700 kHz

Usable sensitivity 12 μV / (500 μV / m)

Total harmonic distortion 0.7 %

Signal to noise ratio 48 dB

Selectivity 30 dB

General

Power consumption 2.3 A

AC outlet

SWITCHED 2: (total 200 W, 1.6 A max.)

Dimensions W:440 mm (17-5/16")

H:143 mm (5-5/8")

D:340 mm (13-3/8")

Weight (net) 8.2 kg (18.1 lb)

(For other countries)

Audio section

Rated power output at the STEREO operation

(EIAJ) 1 kHz, 10 % T.H.D., at 8 Ω 80 W + 80 W

(DIN/IEC) from 63 Hz to 12.5 kHz,

0.7 % T.H.D., at 8 Ω 60 W + 60 W

Power output at the Surround operation

Front (1 kHz, 0.9 % T.H.D. at 8 Ω) 50 W + 50 W

Center (1 kHz, 0.9 % T.H.D. at 8 Ω) 50 W

Rear (1 kHz, 0.9 % T.H.D. at 8 Ω) 20 W + 20 W

Total harmonic distortion (1 kHz, 8 Ω) 0.03 % at 30 W

Signal to noise ratio (IHF'66)

PHONO (MM) 74 dB

CD, TAPE, VIDEO 100 dB

Input sensitivity / impedance

PHONO (MM) 2.5 mV / 47 kΩ

CD, TAPE, VIDEO 200 mV / 47kΩ

Tone controls

BASS ± 10 dB (at 100 Hz)

TREBLE ± 10 dB (at 10 kHz)

Loudness control at -30 dB level + 6 dB (100 Hz)

Video section

VIDEO inputs / outputs (Composite) 1 Vp - p / 75 Ω

FM Tuner section

Tuning frequency range 87.5 MHz ~ 108 MHz

Usable sensitivity (IHF) 13.2 dBf (1.2 μV at 75 Ω)

50 dB quieting sensitivity

STEREO 41.2 dBf (32 μV at 75 Ω)

Total harmonic distortion at 1 kHz

MONO 0.6 %

STEREO 0.7 %

Signal to noise ratio at 65 dBf (IHF)

MONO 75 dB

STEREO 68 dB

Selectivity (IHF ± 400 kHz) 50 dB

Stereo separation (IHF at 1 kHz) 40 dB

AM Tuner section

Tuning frequency range

9 kHz 531 kHz ~ 1,602 kHz

10 kHz 530 kHz ~ 1,610 kHz

Usable sensitivity 12 μV / (500 μV / m)

Total harmonic distortion 0.7 %

Signal to noise ratio 48 dB

Selectivity 30 dB

General

Power consumption 200 W

AC outlet

SWITCHED 2: (total 200 W max.)

(Except for Australia)

Dimensions W:440 mm

H:143 mm

D:340 mm

Weight (net) 8.2 kg

Note

KENWOOD follows a policy of continuous advancements in development. For this reason specifications may be changed without notice.



.....
.....
.....
.....
.....
.....



KENWOOD

